

TOOL HOLDERS

BMT

BMT Taper Standard

BMT 锥柄标准

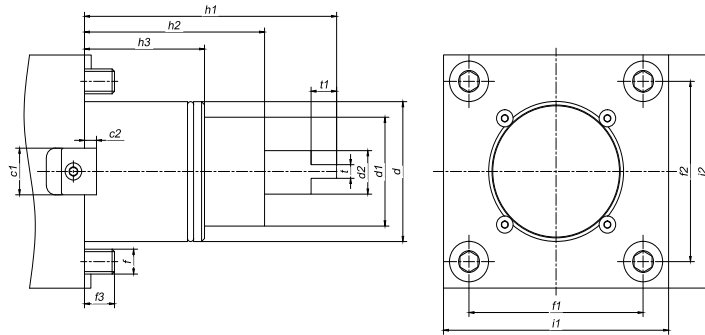

Type	c1	c2	d	d1	d2	f	f1	f2	f3	h1	h2	h3	i1	i2	t	t1
BMT45	15	4	45	35	14	M8	58	58	10	84	60	40	75	75	6	8.5
BMT55	15	4	55	40	16	M10	64	64	14	104	75	30	85	85	8	8.5
BMT65	18	5	65	45	18	M12	70	73	15	112	83	32	94	94	10	14
BMT75	25	5	75	55	23	M12	90	90	15	110	80	43	112	112	14	15
BMT85	25	5	85	65	33.5	M12	100	100	18	140	100	43	125	125	16	20

BMT TOOLING SYSTEM

BMT 工具系统

BMT OD Turning Tool Holder.....	004
BMT 外径刀座, 外出水	004
BMT Double OD Turning Tool Block.....	005
BMT 外径双刀座, 外出水	005
BMT Face Turning Tool Holder.....	006
BMT 短型外径双刀座, 外出水	006
BMT Boring Bar Tool Holders.....	007
BMT 外径双刀座, 外部出水	007
BMT Facing Tool Holder.....	008
BMT 端面刀座, 外部出水	008
BMT Boring Bar Holder, Internal and External Coolant.....	009
BMT 内孔刀座, 内出水 + 外出水	009



BMT OD Turning Tool Holder

BMT 外径刀座, 外出水

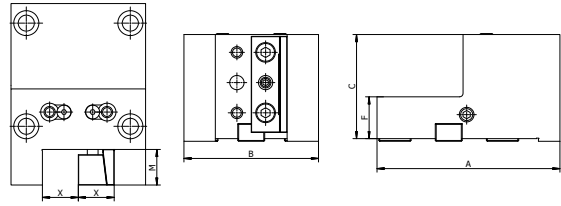

Metric

Size	X	A	B	C	F	M
BMT45-OD20-60	20	105	75	60	30	20
BMT55-OD20-60	20	120	85	60	30	20
BMT55-OD25-75	25	126	85	75	30	25
BMT65-OD20-75	20	131	96	75	30	20
BMT65-OD25-75	25	131	96	75	30	25
BMT75-OD25-85	25	145.5	112	85	35	25
BMT75-OD25-100	25	145.5	112	100	35	25
BMT75-OD32-85	32	153	112	85	35	32
BMT75-OD32-100	32	153	112	100	35	32
BMT85-OD32-75	32	174	130	75	40	32
BMT85-OD32-90	32	168.5	130	90	40	32
BMT85-OD32-120	32	168.5	130	120	50	32

Inch

Size	X	A	B	C	F	M
BMT45-OD19.05-60	19.05	105	75	60	30	19.05
BMT55-OD19.05-60	19.05	120	85	60	30	19.05
BMT55-OD25.4-75	25.4	126	85	75	30	25.4
BMT65-OD19.05-75	19.05	131	96	75	30	19.05
BMT65-OD25.4-75	25.4	131	96	75	30	25.4
BMT75-OD25.4-85	25.4	145.5	112	85	35	25.4
BMT75-OD25.4-100	25.4	145.5	112	100	35	25.4
BMT75-OD31.75-85	31.75	153	112	85	35	31.75
BMT75-OD31.75-100	31.75	153	112	100	35	31.75
BMT85-OD31.75-75	31.75	174	130	75	40	31.75
BMT85-OD31.75-90	31.75	168.5	130	90	40	31.75
BMT85-OD31.75-120	31.75	168.5	130	120	50	31.75

BMT Double OD Turning Tool Block

BMT 外径双刀座, 外出水

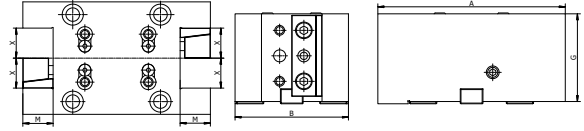

Metric

Size	X	A	B	G	M
BMT45-OD20D-60	20	124	75	60	20
BMT55-OD20D-65	20	152	85	65	20
BMT55-OD25D-65	25	152	85	65	25
BMT65-OD25D-75	25	157	96	75	25
BMT75-OD32D-85	32	185	112	85	32

Inch

Size	X	A	B	G	M
BMT45-OD19.05D-60	19.05	124	75	60	19.05
BMT55-OD19.05D-65	19.05	152	85	65	19.05
BMT55-OD25.4D-65	25.4	152	85	65	25.4
BMT65-OD25.4D-75	25.4	149	96	75	25.4
BMT75-OD31.75D-85	31.75	185	112	85	31.75

BMT Face Turning Tool Holder

BMT 短型外径刀座, 外出水

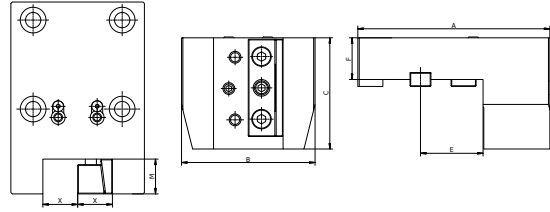

Metric

Size	X	A	B	C	E	F	M
BMT45-ODS20-65-E41	20	127	75	65	41	30	20
BMT55-ODS25-80-E46	25	138	85	80	46	30	25
BMT55-ODS25-80-E51	25	138	85	80	51	30	25
BMT65-ODS25-80-E56	25	146	96	80	56	40	25
BMT75-ODS25-100-E58.5	25	168	112	100	58.5	50	25
BMT75-ODS32-100-E58.5	32	168	112	100	58.5	50	32
BMT85-ODS32-110-E71	32	190	130	110	71	50	32

Inch

Size	X	A	B	C	E	F	M
BMT45-ODS19.05-65-E41	19.05	127	75	65	41	30	19.05
BMT55-ODS25.4-80-E46	25.4	138	85	80	46	30	25.4
BMT55-ODS25.4-80-E51	25.4	138	85	80	51	30	25.4
BMT65-ODS25.4-80-E56	25.4	146	96	80	56	40	25.4
BMT75-ODS25.4-100-E58.5	25.4	168	112	100	58.5	50	25.4
BMT75-ODS31.75-100-E58.5	31.75	168	112	100	58.5	50	31.75
BMT85-ODS31.75-110-E71	31.75	190	130	110	71	50	31.75

BMT Boring Bar Tool Holders

BMT 外径双刀座, 外出水

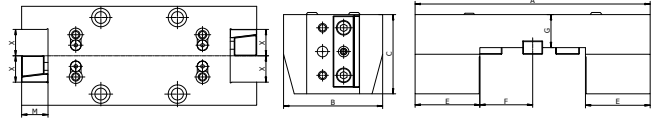

Metric

Size	X	A	B	C	E	F	G	M
BMT45-ODS20D-65-E41	20	164	75	65	41	41	30	20
BMT55-ODS25D-80-E46	25	188	85	80	51	43	30	25
BMT55-ODS25D-80-E51	25	178	85	80	46	43	30	25

Inch

Size	X	A	B	C	E	F	G	M
BMT45-ODS19.05D-65-E41	19.05	164	75	65	41	41	30	19.05
BMT55-ODS25.4D-80-E46	25.4	188	85	80	51	43	30	25.4
BMT55-ODS25.4D-80-E51	25.4	178	85	80	46	43	30	25.4

BMT Facing Tool Holder

BMT 端面刀座, 外部出水

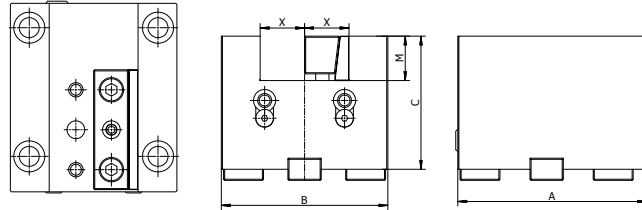

Metric

Size	X	A	B	C	M
BMT45-F20-65	20	86	75	65	20
BMT45-F20-80	20	86	75	80	20
BMT55-F20-70	20	95	85	70	20
BMT55-F25-70	25	105	85	70	25
BMT65-F25-82.5	25	100	96	82.5	25
BMT65-F25-120	25	100	96	120	25
BMT75-F25-70	25	120	112	70	25
BMT75-F25-135	25	120	112	135	25
BMT75-F25-122	25	120	112	122	25
BMT75-F32-100	32	120	112	100	32
BMT75-F32-122	32	120	112	122	32
BMT85-F32-105	32	168.5	130	105	32
BMT85-F32-140	32	168.5	130	140	32

Inch

Size	X	A	B	C	M
BMT45-F19.05-65	19.05	86	75	65	19.05
BMT45-F19.05-80	19.05	86	75	80	19.05
BMT55-F19.05-70	19.05	95	85	70	19.05
BMT55-F25.4-70	25.4	105	85	70	25.4
BMT65-F25.4-82.5	25.4	100	96	82.5	25.4
BMT65-F25.4-120	25.4	100	96	120	25.4
BMT75-F25.4-70	25.4	120	112	70	25.4
BMT75-F25.4-135	25.4	120	112	135	25.4
BMT75-F25.4-122	25.4	120	112	122	25.4
BMT75-F31.75-100	31.75	120	112	100	31.75
BMT75-F31.75-122	31.75	120	112	122	31.75
BMT85-F31.75-105	31.75	168.5	130	105	31.75
BMT85-F31.75-140	31.75	168.5	130	140	31.75

BMT Boring Bar Holder, Internal and External Coolant

BMT 内孔刀座, 内出水 + 外出水

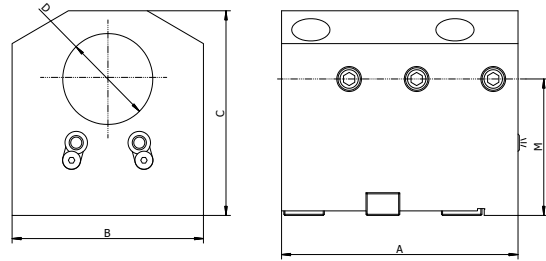

Size	D	A	B	C	M
BMT45-ID25-H65-95	25	95	75	95	65
BMT45-ID32-H65-95	32	95	75	95	65
BMT45-ID40-H65-95	40	95	75	95	65
BMT45-ID32-H85-115	32	95	75	115	85
BMT45-ID40-H85-115	40	95	75	115	85
BMT55-ID25-H100-130	25	105	85	130	100
BMT55-ID32-H60-90	32	105	85	90	60
BMT55-ID32-H70-100	32	105	85	100	70
BMT55-ID32-H85-115	32	105	85	115	85
BMT55-ID32-H100-130	32	105	85	130	100
BMT55-ID40-H60-90	40	105	85	90	60
BMT55-ID40-H70-100	40	105	85	100	70
BMT55-ID40-H85-115	40	105	85	115	85
BMT55-ID40-H100-130	40	105	85	130	100
BMT65-ID32-H72-107	32	126	95	107	72
BMT65-ID32-H100-135	32	126	95	135	100
BMT65-ID40-H72-107	40	126	95	107	72
BMT65-ID40-H85-120	40	126	95	120	85
BMT65-ID40-H100-135	40	126	95	135	100
BMT65-ID40-H115-150	40	126	95	150	115
BMT65-ID50-H72-112	50	126	95	112	72
BMT65-ID50-H90-130	50	126	95	130	90
BMT65-ID50-H100-140	50	126	95	140	100

BMT Boring Bar Holder, Internal and External Coolant BMT 内孔刀座, 内出水 + 外出水

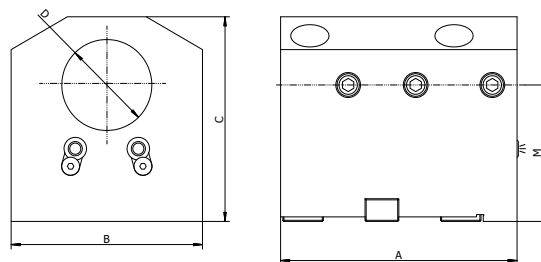

Size	D	A	B	C	M
BMT75-ID40-H60-105	40	135	112	105	60
BMT75-ID40-H90-135	40	135	112	135	90
BMT75-ID50-H90-135	50	165	112	135	90
BMT75-ID50-H110-155	50	165	112	155	110
BMT75-ID50-H125-170	50	165	112	170	125
BMT75-ID60-H60-105	60	165	112	105	60
BMT75-ID60-H90-135	60	165	112	135	90
BMT75-ID60-H110-155	60	165	112	155	110
BMT75-ID60-H125-170	60	165	112	170	125
BMT75-ID63-H110-155	63	165	112	155	110
BMT85-ID50-H85-132	50	161.5	130	132	85
BMT85-ID60-H85-132	60	161.5	130	132	85
BMT85-ID80-H85-137	80	161.5	130	137	85
BMT85-ID50-H110-157	50	161.5	130	157	110
BMT85-ID60-H110-157	60	161.5	130	157	110
BMT85-ID80-H110-162	80	161.5	130	162	110

BMT Boring Bar Holder, Internal and External Coolant

BMT 内孔刀座, 内出水 + 外出水

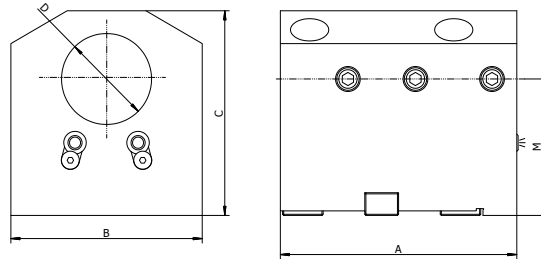

Size	D	A	B	C	M
BMT45-ID25.4-H65-95	25.4	95	75	95	65
BMT45-ID31.75-H65-95	31.75	95	75	95	65
BMT45-ID40-H65-95	40	95	75	95	65
BMT45-ID31.75-H85-115	31.75	95	75	115	85
BMT45-ID38.1-H85-115	38.1	95	75	115	85
BMT55-ID25.4-H100-130	25.4	105	85	130	100
BMT55-ID31.75-H60-90	31.75	105	85	90	60
BMT55-ID31.75-H70-100	31.75	105	85	100	70
BMT55-ID31.75-H85-115	31.75	105	85	115	85
BMT55-ID31.75-H100-130	31.75	105	85	130	100
BMT55-ID38.1-H60-90	38.1	105	85	90	60
BMT55-ID38.1-H70-100	38.1	105	85	100	70
BMT55-ID38.1-H85-115	38.1	105	85	115	85
BMT55-ID38.1-H100-130	38.1	105	85	130	100
BMT65-ID31.75-H72-107	31.75	126	95	107	72
BMT65-ID31.75-H100-135	31.75	126	95	135	100
BMT65-ID38.1-H72-107	38.1	126	95	107	72
BMT65-ID38.1-H85-120	38.1	126	95	120	85
BMT65-ID38.1-H100-135	38.1	126	95	135	100
BMT65-ID38.1-H115-150	38.1	126	95	150	115
BMT65-ID50.8-H72-112	50.8	126	95	112	72
BMT65-ID50.8-H90-130	50.8	126	95	130	90
BMT65-ID50.8-H100-140	50.8	126	95	140	100

BMT Boring Bar Holder, Internal and External Coolant BMT 内孔刀座, 内出水 + 外出水

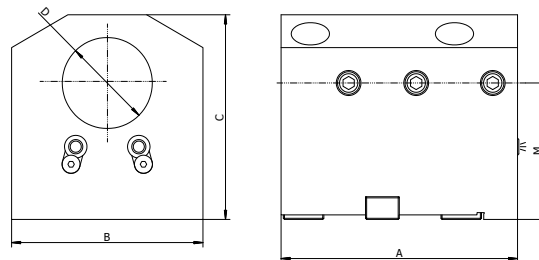

Size	D	A	B	C	M
BMT75-ID38.1-H60-105	38.1	135	112	105	60
BMT75-ID38.1-H90-135	38.1	135	112	135	90
BMT75-ID50.8-H90-135	50.8	165	112	135	90
BMT75-ID50.8-H110-155	50.8	165	112	155	110
BMT75-ID50.8-H125-170	50.8	165	112	170	125
BMT75-ID60-H60-105	60	165	112	105	60
BMT75-ID63.5-H90-135	63.5	165	112	135	90
BMT75-ID63.5-H110-155	63.5	165	112	155	110
BMT75-ID63.5-H125-170	63.5	165	112	170	125
BMT85-ID50.8-H85-132	50.8	161.5	130	132	85
BMT85-ID63.5-H85-132	63.5	161.5	130	132	85
BMT85-ID76.2-H85-137	76.2	161.5	130	137	85
BMT85-ID50.8-H110-157	50.8	161.5	130	157	110
BMT85-ID63.5-H110-157	63.5	161.5	130	157	110
BMT85-ID76.2-H110-162	76.2	161.5	130	162	110